

THIS NEWSLETTER IS PUBLISHED BY THE
PORT ELIZABETH AMATEUR RADIO SOCIETY

Web site: pears.8m.com

e-mail glaaks@iafrica.com

P.O. BOX 10402
LINTON GRANGE
6015

May 1999

ANNUAL GENERAL MEETING

The **Annual General Meeting** of the Port Elizabeth Amateur Radio Society will be held on **Saturday, 22 May 1999**, commencing at **15:00 (3.00 pm)** in the **Walmer Scout Hall, Fordyce Road, Walmer (near 4th Avenue)**. *Please note the change of time – not 2pm as stated last month.*

Please see last month's issue of QSX for the agenda. No motions for discussion have been received.

Immediately before and again after the meeting, there will be a **boot sale** in the grounds of the scout hall. Anyone who has usable "junk" to dispose of is welcome to bring it along and flog or swap it. A percentage of your takings for PEARS will be welcome but is not a requirement.

The meeting will also be followed by a **bring-and-braai**, for which the Society will provide the fires as well as a few cartons of wine, fruit juice and ice cream

Please bring your own cats and other liquid refreshments as well as utensils, drinking glasses, stools etc.

All members and other radio amateurs and their families are welcome to this, the last PEARS AGM of the 20th Century. Let's make it a good one again. (Just for the record, only paid-up members will be allowed to vote, of course).

Wrinkly Ravers

The **next rave** will be on **Thursday, 3 June** at the Zwartkops Yacht Club Clubhouse. Amble in from about 12 noon. This will be something pleasant to look forward to while you stand in the queue to cast your vote the previous day.

Just think - we're already in the middle of the last year of the millennium! Or are there actually still *18 months* to go to the end? There's some controversy about that, but it's all a question of arithmetic and hardly worth bothering about when you get to *our* age. In any case, who of you codgers can still *do* arithmetic? (It's now called *math* (singular, not *maths* like in our dim distant schooldaze).

If you need to phone Ken to confirm your booking for the Rave, his phone number is [041] 466-1786. His surname is Tremeer, pronounced the English way like Tree'mear - *not* Trim'air or (horrors) Truh'mêr. You *know* how crabby one can get about these things, so practise a little before you phone him.

'Ken', of course, is pronounced the Scottish way, like in "D'ya ken John Peel?", not like in "Keen".

On second thoughts, ask to talk to Judy. Pronounced Joo'dee.

REMINDER - Subs are now a little overdue and this should be the last issue of QSX for non-renewers. Please remit your subs right away.



A Word

From the Chair



It is not an easy task to write one of these "chairman's reports" – Time seems to pass so quickly, and I feel out of touch with what is really happening in the lives of our members. To sum up, I have once again made use of the last year's worth of QSX to catch up...

Some of the happenings over the last year in the life of the PE Amateur Radio Society:

- Good technical construction articles in QSX
- 650 Town repeater has a UHF link added, allowing two different link paths to be remotely switched
- Repeater network provides "moral support" to a ham threatened by veld fires in the Southern Cape
- The new 2m beacon transmitter was installed, thanks to Mike, Al and helpers
- VW rally was held once more, in a most professional manner – congratulations to the organising sub-committee
- Wrinkly raves continue to be an institution
- CW classes were held on-air by Bryan
- Crackle problems at Grahamstown repeater cleared up
- Day-trip to Roger, ZS1J in Plett
- Jamboree on the air station set up at VPHS
- HF Packet frequency changed to 3605kHz
- Wrinkly rave held at Bushmans River Mouth
- PEARS Honorary life membership awarded to ZS2Y and ZS2BY
- PEARS VHF/UHF Contest initiated
- VHF DX net on 144.450MHz gains popularity
- Cradock Repeater site totally re-installed, with UHF link to Grahamstown
- 6m Link added to Lady's Slipper after a long absence, but suffers interference
- Grahamstown Science Festival display stand set up and manned for the week
- Some progress is made in linking the VHF network to Cape Town

Although written in one line, some of these activities were major undertakings, done for the first time. Special mention must be made of the Grahamstown Science Festival, where a really impressive display stand was erected for the duration of the show. Many volunteers gave of their time and energy, for which I thank them.

I am somewhat disappointed within myself for the lack of drive on the social side of things over the past year. May that be a focus area for the incoming committee – to get the monthly meetings back to the organised events they used to be. Far too often

[To page 4]

HAMNET / ECARES NEWS

Hamnet/Ecares General Meeting

The next meeting will be held on Wednesday, 26 May at 19:30 at the Municipal Disaster Management Centre.

At the meeting we will have a display of old radio equipment, homebrew or commercial. If you have any items that you wish to display, do bring it along. There will also be some equipment available free of charge.

Telephone numbers, addresses

There have been a number of changes in telephone numbers recently, so all Hamnet/Ecares members are requested to please let me have their telephone numbers and addresses – even if they have not changed – in order to update our records.

The General Election

The general election takes place on 2 June but so far it appears that we will not be involved in any way, other than our normal emergency activities. Our members are however asked to monitor somewhat more than usual around this period.

New Member

We welcome another new member to Ecares, namely Neville Roebert ZS2NR. It is good to have Ecares represented in King William's Town as well.

73,

Al Akers ZS2U
Provincial Director,
Hamnet East Cape/ECARES

Word from the Chair (from page 3)

we have not had any form of planned entertainment for these get-togethers. For that I apologise. It might be wise for me to stick to the technical side of the repeaters etc.

During the last year we made an attempt to involve younger members on committee, but this has had its disadvantages – I find that the younger chaps (a non gender-specific term here, please) are very involved in saltmine and "other" sporting activities which compete for their time. More

often than not, the "permanent loafers" are more keen and more reliable than the "smoother" members, myself included! So for all the assistance received through the year from the permanent loafers, most not even on the committee – I thank you sincerely.

I hope to see you at the AGM

God Bless

73,

Chris ZS2AAW

FOR SALE



WANTED



SWOP

FOR SALE OR SWOP

* Kenwood TS120S **transceiver** (for battery operation, i.e. without the matching mains power supply); Hustler **mobile mast and resonators**. Offers? Or will swop for colour portable TV — **Jack Moolman ZS2KU**, tel. [041] 585 7406.

EAST CAPE VISIT TO BATHURST

Your Society decided at a recent general meeting to arrange a get-together in the Port Alfred area on **Wednesday, 16 June**, which is a public holiday.

Neville Vroom ZS2NV has kindly invited us to use his QTH in Bathurst, which has extensive grounds and a very large shed, which will afford protection should the weather not play ball.

We will be joined by hams from the Border Radio Club. However, all hams and their families within reach, whether members or not, are invited to come along and enjoy themselves. Those who participated in the Wrinklies' Bushman's River bash a couple of months ago – in the middle of the working week nogal – will know what to look forward to.

The event will take the form of a bring and braai, with Neville kindly providing the fires and braai facilities.

Participants should please bring everything else that they need, including eats, drinks and utensils – and seats or blankets to sit on.

A map showing the route to Neville's QTH is provided below. There will be a talk-in on 145,500 MHz for anyone who manages to lose himself in the metropolis of Bathurst, probably because he forgot the stupid map at home and turned up the wrong one of the four streets in the thriving city.

We are inviting the new President of the SARL, Hans Potgieter ZS6ALJ and/or the Office Administrator Michelle ZS6TO, to come along and chat with us. PEARS has voted a small contribution towards their costs.

If they manage to come down, they will probably bring a selection of items from the League Bookshop. This is their way of defraying at least some of the costs. You may therefore want to bring your cheque books. ■

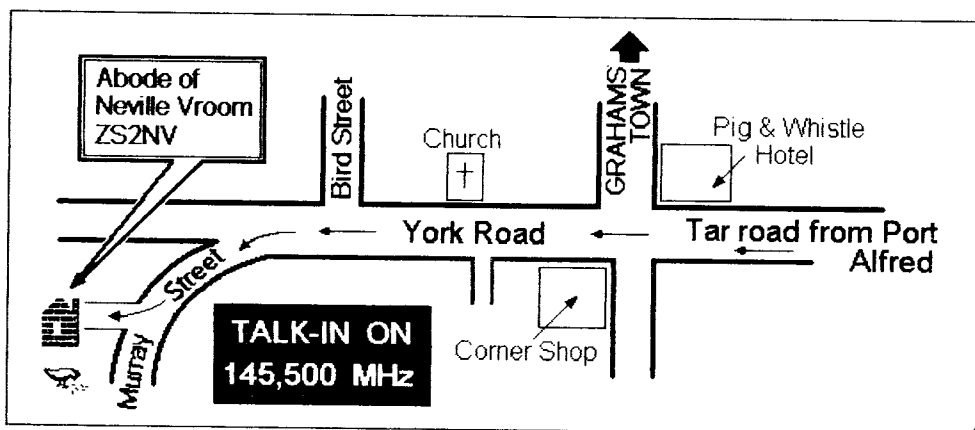

DIRECTIONS— From the Pig & Whistle Hotel, travel *slowly* along the dirt road for about 600 metres. Bear left into Murray Street and, on the right hand side, you will find a sign at the entrance to Neville's property. He will also monitor 145,500 MHz simplex.

SARL HAS NEW PRESIDENT

In his annual report, delivered at the AGM, outgoing President Chris Turner said he felt the time was ripe for a change in leadership, having had three years each as Vice-President and President. Although he was happy to remain on as a Councillor, he had decided to lay down the reins and make way for new blood.

After the AGM, Council unanimously elected Hans Potgieter ZS6ALJ, President and Sid Tyler ZS6AYC Vice President.

PEARS congratulates Hans and Sid on their appointment and trusts that their efforts to revive the League will be met with great and lasting success.

Perhaps with many new, and hopefully free-thinking, councillors and a new-guard President, the "ghosts of Councils past" can be laid to rest and there will be a return to that relaxed *esprit de corps* that was once the hallmark of amateur radio throughout the country.

We express our thanks to Chris Turner ZS6GM for his unstinting efforts during his term of office. He took over at a very difficult time in the League's history and burned barrels of midnight oil pursuing the interests of the League and Amateur Radio.

We hope that his move from the "hot seat" to the "back burner" will afford him a little more time for his other activities and responsibilities.

The SARL's new HQ building was opened officially on 23 April and, from various comments heard on the bands, it is a practical yet attractive edifice and should satisfy the SARL's needs for now.

Some 1200 people are reported to have passed through the gates on the Saturday, mainly to get to the flea market and exhibits by various suppliers of ham-related equipment, or to attend the fascinating demonstrations by Tony ZS6CCD or the discussions on other facets of ham radio.

Council's motion for the inclusion,

without option, of Radio ZS and the QSL Bureau facilities in the basic subscription package was carried unanimously. Strangely, last year, a similar motion from PE was thrown out!

The SARL subscriptions for 1999/2000, which include Radio ZS and the use of the Bureau (presumably with a basic limit) will be as follows:

Ordinary member	R215
Senior member	R175
Spouse	R 35
Incapacitated/Blind/Subsidised	R175
Non-transmitting	R75
Club affiliation	R215
Sponsor	R2000
Ordinary outside RSA	R290
Student	R75

The "Junior" category of membership has been withdrawn. Such members are now grouped in the Non-transmitting category.

The inclusion of Radio ZS as part of the basic package means, in theory, that nearly 50% more members will receive it than the mere thousand or so who have subscribed to the magazine up to now (the League had 1486 paid-up members at the date of the AGM).

CONTACTING SARL HQ

Telkom has yet to lay a cable to the new SARL HQ building and the work may take another few weeks. Sentech has kindly relinquished one of its lines temporarily and you can now reach the SARL on (011) 484-2830. However, the line is likely to be quite busy, so you can leave messages on the SARL Voicemail facility at 088 120 5042, and Michelle will get back to you.

The League's new postal address is PO Box 1721, Strubensvallei 1735, Gauteng. ■

CB TO 6 METRE TRANSVERTER

ANDRÉ BOTES, ZS2ACP

This project secured a second place in the SAARDT competition at ARA99. Only one prize was originally intended but the decision was so close that the judges decided to award a second prize of R250 for André's entry.

It recently became evident, with the tremendous meteor scatter propagation on 50 MHz, how many people were interested in 6 metres but could not join in the fun because they only had FM transceivers or no 6 metre equipment at all.

This easy modification will allow the homebrewer to construct an external transverter to be used in conjunction with an SSB CB set to which no major modifications have to be done at all!

The mixer circuit described here is similar to that used for the 7 MHz conversion (see RADIO ZS, October 1997 and April 1998) but with important differences in the tuned circuits and choice of crystal. The sum of the CB frequency plus the mixer's crystal frequency will determine where in the 6 metre band you will come out.

Note that this project is intended to drive a recycled commercial or other VHF amplifier that you will need to acquire yourself. It should have a pre-driver stage of its own since the output from this unit's pre-driver is very low – only a couple of milliwatts.

Since a 40 channel CB set will give you 400 kHz coverage in the band, choose a crystal that will place you in the segment of the 6 metre

band where you wish to operate. (As the DX section is in the low part of the band, i.e. 50,000 to 50,200, this will be the choice in the majority of cases.)

Channel 1 on all CB sets is 26,965 MHz and a crystal of 23,035 would be needed for 50 MHz exactly. This is an oddball frequency, so check for a 23,000 MHz crystal in the junk box as this will work nicely.

The oscillator used in this project operates at the *fundamental* frequency of the crystal, and you should ensure that the correct frequency is generated when you

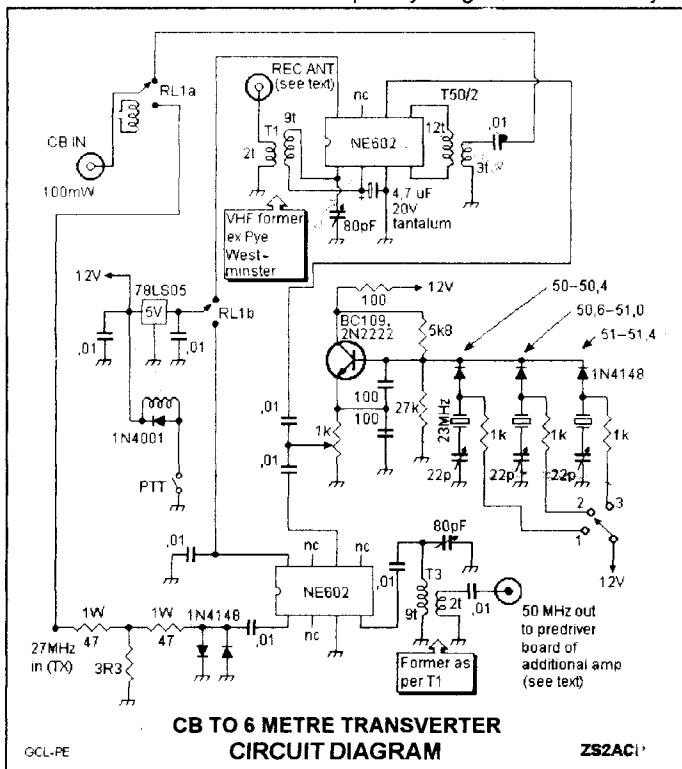

power it up! An *overtone* crystal may well be marked 23 MHz but it will actually oscillate at a fraction – a sub-multiple – of its marked frequency in this circuit!

Populating the board is pretty straightforward. Ensure that you do not deviate from the capacitor values as stated and keep all connections as short as possible.

The TX output power of the CB set must be turned down to no more than 100 mW otherwise saturation of the mixer will result.

The gain of the pre-driver and linear amplifier added after the mixer board will determine the final output on 6 metres. I managed to scrounge the final out of a commercial "no name brand" VHF radio, biased it for SSB operation and am quite happy with the resulting 10 watts.

The linear amplifier that you select should also have its own antenna relay, the 'receive' contact of which should be connected to the terminal marked REC ANT on the mixer board.

If you wish to use the mixer just for receiving 6 metre signals, you can connect

your antenna direct to this point, of course.

ALIGNMENT

Receiver

Set the preset potentiometer to mid position. Select a channel on the CB set to receive an appropriate 6 metre signal, the frequency of which will be the sum of the oscillator and the CB frequency. A strong local station or beacon would be ideal.

Adjust the input trimmer (the 80pF capacitor at T1) for strongest received signal. The result should be very good.

Final tweaking of the CB's front end may improve the signal even further. (I made provision for adding a low noise pre-amp to my unit at a later stage but found this to be unnecessary).

Transmitter

Connect a frequency counter to the output of the TX mixer marked "To separate predriver". Switch the CB set to transmit in the AM mode. Adjust the 80pF transmit trimmer near T3 so that the counter displays a frequency in the 50 MHz range (depending on the crystal you have selected) thus ensuring that the filter

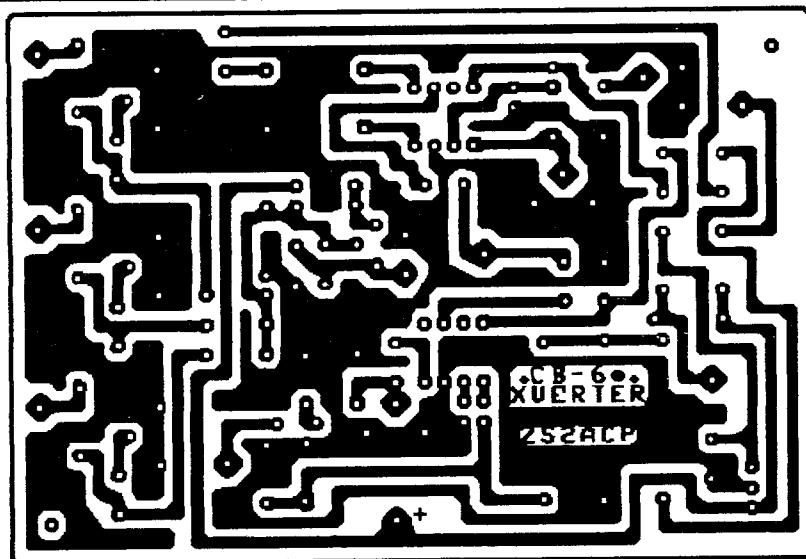

PC board – copper side (actual size) for the CB-6m transverter

is suppressing the unwanted mixer frequencies.

To adjust the output to the exact frequency, each crystal should be selected in turn and its associated trimmer tweaked for an appropriate reading on the counter.

If a 50 MHz receiver is available and a small length of wire is attached to where the frequency counter was connected, you should be able to monitor yourself on the receiver.

Input and Output coils

The 6mm formers seen in the photograph were removed from an old Pye Westminster transceiver, but almost any 5 to 7 mm former would do as long as the pins line up with the PC board. The coils are not fitted with slugs.

Should sufficient interest be shown, I will consider publishing options for adding FM to the CB set and a complete linear

amplifier, including a pre-driver, that will be suitable for use with the mixer board described above.

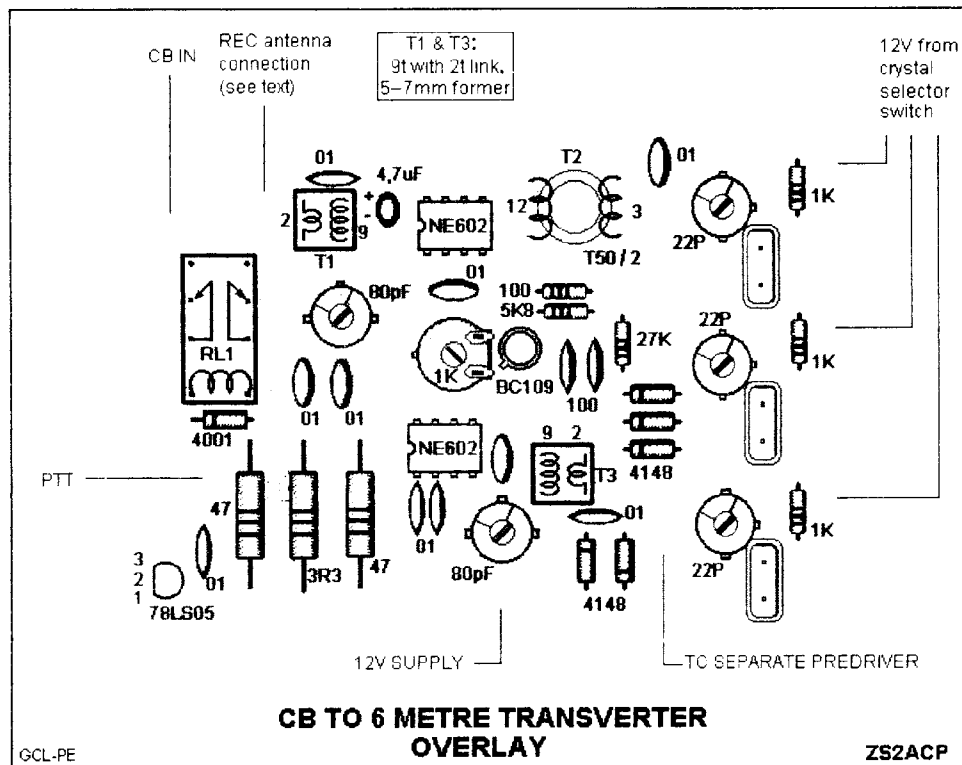
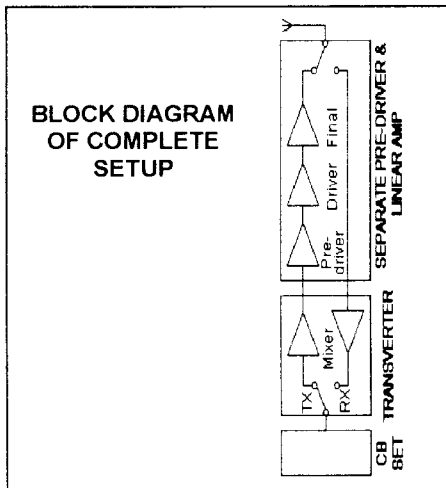

MINUTES OF THE ANNUAL GENERAL MEETING OF THE PORT ELIZABETH AMATEUR RADIO SOCIETY, HELD IN THE WALMER SCOUT HALL, FORDYCE ROAD, WALMER, PORT ELIZABETH ON SATURDAY, 16 MAY 1998

1. **Opening & welcome:** Chairman Chris ZS2AAW opened the meeting and welcomed everybody, especially Van ZS2Y, Colin ZS2CR, Roger ZS1J and XYL Nita.

The meeting then observed a moment's silence in remembrance of Ron Herman ZS2R, who had recently passed away.

2. **Present and apologies:** Attendance as per the register: 47 members, 7 visitors.

Apologies were tendered on behalf of several members and wellwishers.

3. **Minutes of AGM held on 17 May 1997:** Proposed by Dick ZS2RS, seconded by ZS2HB. Accepted.

4. **Matters arising:** Nothing.

5. **Chairman's report:** The Chairman's report was published in the May issue of QSX. Chris thanked all members of PEARS for the excellent spirit that prevailed, and especially for the absence of 'politics' that bedevilled the club in years past.

Acceptance of the report was proposed by Lynn ZS2MM, and seconded by Lionel ZS2DD.

6. **Treasurer's report:** Members were handed a copy of the financial statement at the meeting, and Treasurer Clive ZS2RT highlighted the main points of interest.

Acceptance proposed by Ken ZS2BWB, and seconded by Bill ZS2ABZ.

The Chairman thanked Clive for the good work throughout the year, and also our honorary auditor Gus ZS2MC.

7. **Awards:** The following awards were presented—

'Ou Toppie Certificate' to Peter ZS2PL, whose 80th birthday was just around the corner. [The Ed refrains from offering the obvious comment!]

Merit certificates—

- for outstanding work in extending and maintaining our repeater network – Chris Scarr ZS2AAW
- for his involvement with technical classes and general assistance to fellow hams – Viv Moore ZS2VM
- for establishing the 'Wrinkly Ravers' – Ken Tremeer ZS2BWB.
- for initiative and excellent job of creating our Web page – Gary Laaks ZR2ABU
- for his perseverance in the use of CW in spite of considerable difficulty – Bryan Haecele ZS2BH

Trophies—

- ZS2OB DX Trophy – Ken Tremeer ZS2BWB
- VHF Trophy – Alex Gogos ZR2T
- ZS2AB Constructor's Trophy – jointly to Phil Hopper ZS2PP & Ewan Mathieson ZS2EN
- Ham Spirit Trophy – Shawn Corder ZR2SC

The following awards from the SARL were also handed out –

- Arthur Hemsley VHF Trophy – Alex Gogos ZR2T
- J J Pienaar Trophy – Mike Bosch ZS2FM

8. **Election of Chairman:** Lionel ZS2DD took the chair, and Chris ZS2AAW was unanimously re-elected. A nameless wag proposed Louis Luyt, which raised some sounds of mirth from the assembly.

9. **Election of committee:** The following were elected to the committee—

<u>Elected</u>	<u>Proposer</u>	<u>Secunder</u>
Clive ZS2RT	Gus ZS2MC	Garth ZS2HB
Shawn ZR2SC	Dick ZS2RS	Nicolas ZR2NDT
Garth ZS2HB	Fred ZS2JS	Lionel ZS2DD
Dick ZS2RS	Trevor ZS2AE	Lionel ZS2DD
Jacques ZR2JH	Chris ZS2AAW	Neil ZR2NT
Bill ZS2ABZ	Clive ZS2RT	Lionel ZS2DD

10. **Motions:** Both motions were carried unanimously.

11. **Report-back by Garth ZS2HB on the SARL AGM:** The highlights of Garth's report-back were—

- The format of the meeting was different to that in previous years, and there was also a different atmosphere.
- There were 60 SARL members present, with 213 proxies.
- The motion proposing that the SARL revert back to the previous structure having branches was lost. The meeting felt the present structure should be given a few years to prove its success or otherwise.
- SARL membership is in a steady decline. Members need to be recruited to League membership as a matter of urgency.
- A committee was set up to investigate whether there should be mandatory membership of the SARL.
- The SARL is working towards RAE examinations no longer being limited to fixed dates but exams being held whenever there is a predetermined minimum number of candidates ready to write.
- HQ seem to have got their financial act together and trimmed their operating budget.
- PEARS was singled out as one of the more progressive 'clubs'.

Chairman Chris thanked Garth for representing PEARS members at the AGM, and also for refusing any payment in respect of his travelling expenses.

12. **General**

1. Nicolas ZR2NDT gave a brier report on the activities of the younger members. Shawn ZR2SC also added a few words, and mentioned that more braais were in the pipeline.
2. Ken ZS2BWB made the point that PEARS membership had outgrown the capacity of the Civil Defence Centre that was used as our meeting place, and suggested it was time we started looking for another venue. Garth ZS2HB remembered seeing what could be a suitable venue at Telkom's college, and he would look into it.
3. Garth ZS2HB enquired when we would be putting up a 4m beacon. Mike ZS2FM said that there was sufficient space at the existing site of the 2m beacon. It was also mentioned that Ken ZS2OC had offered to donate a 70 MHz rig for this purpose.

13. **Closure:** The meeting ended at 16:05, and members headed for the braai fires under idyllic weather condx. ■

PEARStalk

PEARS MEMBERS HONOURED

Two of our members were honoured with awards at the SA Radio League's recent ARA99. Mike Bosch ZS2FM received the Radio ZS Shield for the member who had best supported Radio ZS during the year.

André Botes ZS2ACP took second place in a contest with his excellent CB-to-6 Metre transverter. The result was so close that the organisers decided to grant a second prize of R250, although originally there was to be only a first prize.

On a different front, Roger Davis ZS1J has had the honour of his useful article on modifications to the FT101, which appeared in Radio ZS recently, reprinted in no less a journal than QST. Oddly, the RSGB rejected the article when it was offered to them!

Congrats to all of you.

FREE ID CARDS!

Bryan Haefele ZS2BH has offered to make, free of charge, small ID cards for members who attend PEARS functions to pin to their breast pockets or other suitable places. The cards bear the Society badge and the name and call sign of the member and they are laminated. (The cards, not the members).

Bryan is also able optionally to attach a plastic clip for use in place of a safety pin but he will need to recover the cost – about R1 at present – from those who require the device.

It is a good idea to wear some form of identification, especially when visitors or newcomers are present, so contact Bryan if you want to avail yourself of his kind offer. His telephone number is 365 4100.

9U OUT OF DXCC LIST

The communications authorities in Burundi have declared as forgeries all

documentation regarding operations from that country (prefix 9U) since 1994. The ARRL DXCC body conducted its own investigation and has decided to remove from its records all contacts claimed with stations using a 9U prefix since 1994.

It is not known whether any operators have obtained DXCC on the strength of such contacts.

RAE ON 20 MAY

For the first time in a long while there are no entrants for the RAE in PE that we know of. Although a few people have made known their desire to get into Ham Radio, they came to us too late for the Society to arrange classes with any reasonable expectation of success.

It is likely that classes will be arranged for the second half of the year, aiming at the November examination.

REPEATER LINK TO CAPE TOWN

It seems the planned link to Cape Town is fraught with hassles. Chris Scarr ZS2AAW, together with pa Trevor ZS2AE and Lionel ZS2DD, travelled to George to improve the UHF link towards Riversdale, only to find that something seems to have gone wrong at *that* location. While signals appeared to be going westward *from* our side, no usable signal was being received *from* Riversdale.

Whatever the trouble was, it is sure to be licked soon, so keep an ear on the link for any strange voices.

NB: The improvements at George include the provision of a DTMF switch to exclude this repeater from the link when necessary. Please update your copy of the diagram in last month's QSX by inserting a heavy cross and the digits 7004 just below the George repeater icon marked "145.700", in similar fashion to the other repeaters.

CW PRACTICE SESSIONS

Meanwhile, Bryan Haefele ZS2BH has started CW practice sessions on the linked repeater system every Monday, Wednesday and Friday evening, starting at 7 o'clock. Those who fell by the wayside before, and anyone else wishing to brush up his or her CW acumen, are invited to make use of Bryan's efforts.

He naturally likes to receive reports by one means or another from those who use the service.

NEXT STOP NOUPOORT

Looks like Chris won't stop until he's covered the whole country with 2 metre links. He tells us it's on the cards to extend our link with Cradock to cover Noupoort and environs.

From there it's an easy hop into the Free State. The FS boys already have a repeater system, including a scanning repeater, so it will probably not be long before the whole N1 North comes on stream.

But we must stop short of Gauteng. There are some very rough people using the repeaters up there!

SARL BULLETIN TRANSMISSIONS

If you have been experiencing difficulty understanding the SARL bulletins, either direct on HF or via the relay on the linked repeater system, you will be pleased to learn that the matter will be broached at the upcoming PEARS AGM.

Many members have expressed unhappiness over the quality of the transmissions and also the delivery by some readers. The question will be

discussed fully and taken up with the SARL.

WHO'S WHO

You all no doubt recognized the Who's Who picture on page 6 last month as being a remarkably accurate representation of your Chairman, Chris Scarr ZS2AAW. We think the photo was taken after he ran into an antenna mast or something.

Here he is in typical pose – *up* a mast at our site on Lady's Slipper.

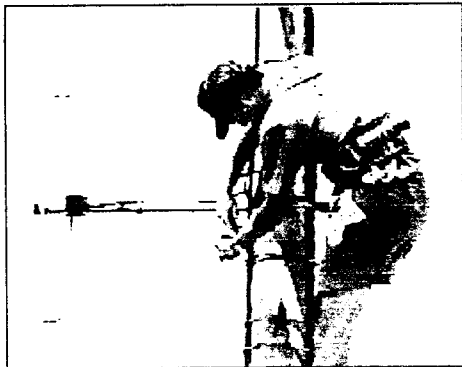

SUBS OVERDUE

Ja, it's the same old nag again.

If you haven't renewed your subs yet, your name is becoming very faint on our distribution list for QSX and it is likely to fade away completely before next month. Moreover, you will not be allowed to vote at the AGM if you are not fully paid-up.

Our Treasurer, Clive, will be happy to relieve you of your bucks before the AGM starts if you haven't already paid by then. ■



Instant Printing

FOR ALL YOUR
PRINTING REQUIREMENTS

9 St. Patricks Road, Port Elizabeth 6001

Telephone: (041) 585-2614

Try us for your QSL cards!



Condolences —Our belated condolences to Dick Schönborn ZS2RS on the passing away of his elder sister on 14 March.

Congratulations...

on your birthdays:

May

- 24 Vicky Ansell XYL of Allan
- 24 Margaret Raven XYL of John ZR2ABH
- 25 Danieel Pretorius ZS2CX
- 26 Daleen Hall ZR2DOL
- 31 Joe Jasson ZR2JLJ
- 31 Dennis Flynn ZS2DB
- 31 Shirley Carr XYL of Stoffel ZS2C

June

- 5 June Jones ZS2JJ
- 7 Maria Marran XYL of Anthony ZR2AI
- 9 Gus Winter ZS2MC
- 10 Ken Victor ZS2OC
- 11 Maureen Fulton XYL of Neil ZS2MG
- 13 Jimmy Hoole ZS2ABM
- 15 Neville Vroom ZS2NV (go easy on the partying, Nev – there's a large, noisy mob descending on you on the morrow!)
- 18 Ossie Osborne ZS1KP

on your anniversaries:

May

- 25 Merle ZR2MP & Neil Thomas ZR2NT

June

- 14 Heather & Jimmy Hoole ZS2ABM
- 16 Peggy & Viv Moore ZS2VM

on your new grandkids Merle and Louis Jordaan ZR2J (a girl) and Jane and Clive Fife ZS2RT (a boy).

on your degrees Robert Bosch ZR2ABK (BSc Phys/Chem) and Joanne Moore, daughter-in-law of Peggy and Viv (B.Proc *Cum Laude*).

Robert is now going for honours. Viv will have to behave himself with a legal eagle hovering around.



Sick List: Jeff Bowes-Taylor ZS1VS, has been under the weather for a while. We wish you a speedy recovery, Jeff – we're missing your cheery "59 in Kommetjie" on the bulletin nets.

Welcome to New Members:

Anthony Marran ZR2AI (whom we incorrectly identified as ZR2AE previously), André Mulder ZR2A of Grahamstown, our old friend Brian Weller ZS2AB who at last found where he had left his cheque book this past year or so,

Hartlik welkom ook aan Piet Fourie ZS2FP van PE, Nico Oelofse ZS4NIC van Barkly Oos en Johan Geyer ZS2OT van Jeffreysbaai. Johan was tot onlangs as ZS4CF bekend. Hy is egter 'n ou Baaienaar wat 'n lang draai of twee gemaak het en is nou terug in die vriendelike streek. Welkom terug, Johan. 

Your Society's Committee

Chairman, Repeaters, Packet	Chris Scarr ZS2AAW	38-1344
Vice Chairman, Social, Special Events	Dick Schönborn ZS2RS	38-5070
Secretary, Repeaters, Packet	Jacques van der Heide ZR2JH	73-3728
Treasurer, Assets Control	Clive Fife ZS2RT	32-3203
Awards, Refreshments, QSX collation	Bill Hodges ZS2ABZ	51-2580
QSX Editor	Garth Laaks ZS2HB	38-1101
e-mail the Editor at	glaaks@iafrica.com	
Assisting QSX collation/distribution	Trevor Scarr ZS2AE	32-1746
Technical Classes	Viv Moore	360-4433
Librarian	Des Herselman ZR2DH	54-2911 (W)
		Cell 083 261 5402 (All Hrs)

PEARS' VHF/UHF & Other Services

REPEATERS

Town VHF	# 145.050/650	Kareedouw	† 145.125/725
Town UHF	# 431.050/438.650	Knysna	* 145.075/675
Cockscomb	145.000/600	Lady's Slipper	* 145.100/700
Craddock	* 145.050/650	Uitenhage	# 145.075/675
Grahamstown	* 145.150/750	Theescombe	† 145.175/775

* These form PE's long-range 2-metre repeater system, to which the East London 145.125/725 MHz repeater and the George repeater on 145.100/700 are also linked. # These can also be linked as required. † These are privately owned repeaters and are not included in the PEARS linked repeater system.

OTHER SERVICES

Packet Bulletin Board (ZSON TP)	144.625
Packet Rose Switch ZS0GHT-3,046101 (144.675 in/out) or 046102 (UHF out to BBS)	144.675
2m Beacon (ZS2VHF CW ID) (horizontally polarized, 160W ERP)	144.410
6m Beacon (ZS2SIX CW ID) (horizontally polarized, 25W ERP)	50.005
6m Simplex Link with Lady's Slipper 2m Repeater (vertically polarized)	51.400
Wefax Relay (Meteosat)	145.350
Web Site	pears.8m.com

Sunday Bulletins

PEARS bulletins are transmitted on Sundays immediately after the SARL English transmission, i.e. at about 08:45 on 7098 kHz as well as the 2 metre linked network that provides coverage from East London to George and environs as well as Craddock via the linked repeater system described above. PEARS' 7098 or 3640 kHz transceive facilities are also remotely linked as needed. In addition, the SARL's 40m transmissions on 7082 or 7066 kHz, alternatively 7070 kHz, can be remotely patched into the 2m network, either in receive-only mode or for full transceive capability for interactive events.

Date	Prepare and Read on 2m Repeater link
16 May	ZS2ABZ
23	Chairman
30	Vice Chairman
6 June	To
13	be
20	announced

DIARY DATES

MAY

17 World Telecoms Day
 20 RAE
22 PEARS A.G.M.
 26 Hamnet Ecares Meeting

JUNE

3 Wrinkly Rave
16 Bathurst Get-together

*** We Like Being Your Society! ***